



MOVING YOU FURTHER

Some of the photos may include optional equipment.

HYUNDAI MATERIAL HANDLING Applied Tier 3 Engine

110/130/160D-7E



Head Office (Sales office)

First tower, 55, Bundang-ro, Bundang-gu, Seongnam-si, Gyeonggi-do, Korea

PLEASE CONTACT

www.hyundai-ce.com

2018. 07 Rev.10



NEW criterion of Big Forklift Truck

Hyundai introduces a new line of 7E-series diesel forklift trucks. Excellent power and performance makes your business more profitable.



Excellent



Cruise Control



Instrument Switch Panel



Rear View Camera
(Optional)



Air Conditioner & Heater
(Optional)



Weight Indicator
(Optional)



ESL(Engine Start Limit)
(Optional)

Some of the photos may include optional equipment.

Ability of best, the new master on the job-site!

Smooth running, efficient and ergonomically designed, 110/130/160D-7E series are made to meet your needs.

Powerful Engine

HYUNDAI HE6.7 Engine

The six cylinders turbo-charged engine is built for power, reliability and economy. This engine meets EPA Tier 3 and EU stage IIIA emission regulation.



Engine Control Mode

According to operating load, the operator can select engine mode by changing side panel switch.

STD Mode : Fuel reduction mode for light-duty operating load

POWER Mode : Heavy-duty or operating at slope



Adjustable Engine Low Idle RPM

While engine runs, low idle rpm can be increased by unit of 25rpm and it keeps previously set rpm when engine restarts.



142kW/2,200rpm
95kgf-m/1,400rpm

Full-automatic Transmission

Full-automatic transmission gives easy, convenient handling and soft, smooth shifting. The operator can select two kinds of automatic modes. (1st→3rd, 2nd↔3rd)



Cruise Control

It offers the ability to automatically maintain a desired engine speed with no accelerator pedal input and reduce fuel consumption.



Transmission Control Switch



Excellent Night Work

- Variety position of work lamp provides the operator more comfortable and safe operating environments.
- Front : fender(2), mast(2) - Rear : cab(2)



Increased Mast Tilting Angle

Utilizing the mast tilting angle of 15 degrees forward and 12 degrees backward, the operator can perform loading and unloading jobs safely and rapidly.

Faster Travel Speed & Better Gradability

The powerful high-output engine provides greater acceleration, better gradability and faster travel speed on any tough terrains or slopes.



Gradability (Loaded)

110D-7E : 47% 130D-7E : 42.4%
160D-7E : 32.4%

Travel Speed (Unloaded)

110D-7E : 33.3km/h 130D-7E : 33.2km/h
160D-7E : 32.3km/h



Some of the photos may include optional equipment.

Ergonomic driving space design!

A design based on human engineering relieves fatigue and increases operator's efficiency.

Operator Friendly Gauges and Water-resistant Monitor Panel



Easily Adjustable Suspension Seat

An attractive and adjustable seat, based on a human engineering design, provides great comfort, safety and durability. (Head Rest - optional)

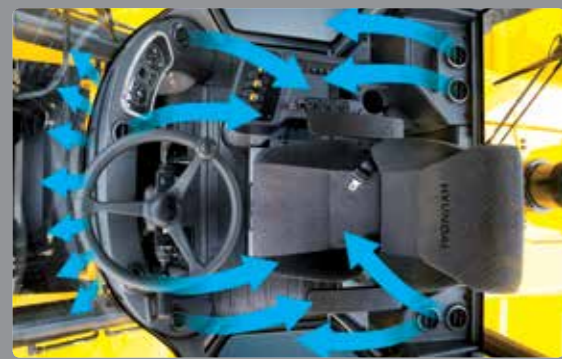

High-output Air Conditioner & Heater (Optional)

An air conditioner with integrated the condenser is mounted on upper side of the cabin to make a wide room in the cabin. And an air conditioner with high-output and heater always provide you comfortable environment when you work.



Some of the photos may include optional equipment.

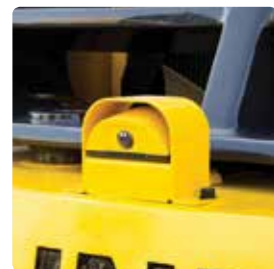

Rear View Camera (Optional)

The rear view camera makes the operation more easy and convenient. And it supports 4 camera channels.

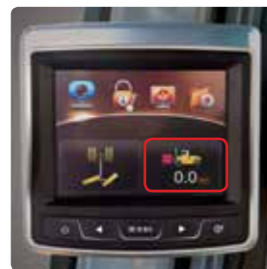

Weight Indicator (Optional)

A load can be placed on the fork and can be accurately weighed by measuring the hydraulic pressure.



Centralized Instrument Switch Panel



USB MP3 Player & Remote Control



Hands Free Socket (Optional)



Quick Response of Operating Control Levers

Only minimal operator's effort is required for precise, safe and productive control. (3-Lever : standard / 4·5-Lever : option)



Ergonomically Positioned Pedals

Based on human engineering ; the accelerator, brake and inching pedals are optimally positioned for the operator's convenience.

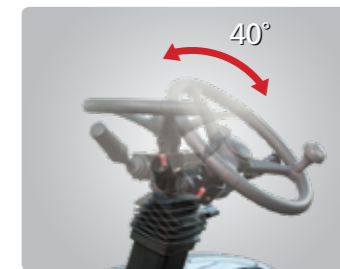

Adjustable Steering Column

Steering handle is adjustable depending on the operator's body shape. Adjustability of steering column makes you more comfortable.



Danger-free through high durability!

Safety and durability are priorities in design of the equipment.



Up-to-date Cooling System

The minimum fuel consumption and low noise are available by applying hydraulic cooling fan sensing intake air temperature, transmission oil temperature, coolant temperature and hydraulic temperature.



OPSS (Operator Presence Sensing System)

Control of mast tilting, lifting and lowering is not possible through operation of the appropriate control when the operators is not in the normal position.



Durable Drive Axle

The hypoid type planetary reduction drive axle smoothly delivers desired torque to the drive wheels.



Auto Parking

The parking brake is engaged automatically when the transmission is neutral and the operator leaves the seat.



Some of the photos may include optional equipment.



Wet Disc Brake System

The wet disc brake system is virtually maintenance free and is enclosed to protect from dust and water.



Fitted Protector for Hub Bolts

Durability has improved by applying protector for preventing bolts breakage. (Easy parts supply due to the wheel in common with front wheel)



Cylinder Guard

This guard helps to prevent possible damage from any foreign material.



Grease Fittings

Grease fittings are installed for fast access to steering axle center pin when doing your service checks.



Highly Durable Mast & Carriage Side Roller

Side roller with great durability for mast and carriage is included.



Highly Durable Carriage

The carriage is very strong cause of applying the high tensile structural steel which has an excellent durability. Work at the narrow space is easy because the width of carriage is narrower than overall width of the vehicle.



Large Footboard & Handle

Wide "open" step offers convenience and safety when entering and exiting the truck.

Centralized design for easy service!

An ideal arrangement of component parts ensures easy access and convenience for maintenance.



Large Engine Hood

Highly accessible engine compartment assures fast and efficient maintenance.



Easy Change Air Cleaner

This air filter is readily accessible for cleaning or replacement.



Cabin Tilting Automatic System

Cabin tilting automatic system makes servicing of all power train components quick and easy. An electrically assisted hydraulic actuated cylinder tilts operator cabin to left side about 65 degrees for easy access to inside of truck components.



Cabin Air Fresh Filter

The internal pressure is maintained to be slightly higher than that of outside to exclude dust and to reduce noise levels.



Some of the photos may include optional equipment.



Compact fuse Box for Easy Inspection



Mechanic Friendly Fuel Filter Replacement

Highly accessible engine compartment allows for quick replacement of filters.



Electrically Monitored Air Filter

Air cleaner sensor alerts the operator of a clogged air filter and allows replacement before damage.



Automatic Self Locking Gas Spring

Engine compartment hood is safely opened by a self locking gas spring.



Master Switch

A master switch disconnects the battery power to protect the electrical system from excess electrical drainage.



Large Tool Box



Pressure Gauge Port



Easy Maintenance Oil Check

Mast Specification

Mast Type	Maximum Fork Height (mm)	Overall Height Lowerd (mm)	Tilt Angle (mm)	Load Capacity (600mm LC) (kg)		Truck Weight Unloaded (kg)		
				110 / 130D-7E	110D-7E	130D-7E	110D-7E	130D-7E
2-Stage Limited Free Lift	V300	3,005	3,000	15 / 12	11,000	13,000	15,722	16,427
	* V330	3,305	3,150	15 / 12	11,000	13,000	15,797	16,503
	V350	3,505	3,250	15 / 12	11,000	13,000	15,847	16,552
	V400	4,005	3,550	15 / 12	11,000	13,000	16,100	16,805
	V450	4,505	3,800	15 / 12	11,000	12,600	16,225	16,930
	V500	5,005	4,100	15 / 12	11,000	12,200	16,374	17,079
	V550	5,505	4,350	15 / 12	11,000	11,800	16,605	17,310
	V600	6,005	4,650	15 / 12	10,600	11,400	16,757	17,462
	V650	6,505	4,900	15 / 12	10,300	11,100	16,890	17,595
V700	7,005	5,150	15 / 12	10,000	10,800	17,021	17,726	
3-Stage Full Free Lift	TF440	4,405	2,950	10 / 10	11,000	12,300	16,761	17,467
	TF470	4,705	3,050	10 / 10	11,000	12,100	16,832	17,538
	TF500	5,005	3,150	10 / 10	11,000	11,800	16,903	17,609
	TF550	5,505	3,317	10 / 10	10,600	11,500	17,070	17,776
	TF600	6,005	3,484	10 / 10	10,300	11,100	17,188	17,894
	TF650	6,505	3,651	10 / 10	9,600	10,800	17,402	18,108
TF700	7,005	3,818	10 / 10	8,700	10,500	17,521	18,227	

Mast Type	Maximum Fork Height (mm)	Overall Height Lowerd (mm)	Tilt Angle (mm)	Load Capacity (600mm LC) (kg)		Truck Weight Unloaded (kg)	
				160D-7E	160D-7E	160D-7E	160D-7E
2-Stage	V300	3,010	3,250	15 / 12	16,000		19,141
	* V330	3,310	3,400	15 / 12	16,000		19,235
	V350	3,510	3,500	15 / 12	16,000		19,280
	V400	4,010	3,750	15 / 12	16,000		19,567
	V450	4,510	4,000	15 / 12	15,900		19,722
	V500	5,010	4,300	15 / 12	15,900		19,904
	V550	5,510	4,550	15 / 12	15,200		20,173
	V600	6,010	4,850	15 / 12	14,600		20,355
	V650	6,510	5,125	15 / 12	14,100		20,521
V700	7,010	5,375	15 / 12	13,800		20,672	
2-Stage Full Free Lift	VS300	3,010	3,200	10 / 10	16,000		19,814
	VS330	3,310	3,350	10 / 10	15,800		19,908
	VS350	3,510	3,450	10 / 10	15,600		19,971
	VS400	4,010	3,700	10 / 10	15,100		20,128
	VS450	4,510	3,950	10 / 10	14,600		20,379
	VS500	5,010	4,250	10 / 10	14,200		20,611
3-Stage Full Free Lift	VS550	5,510	4,500	10 / 10	13,900		20,799
	VS600	6,010	4,800	10 / 10	13,400		21,092
	TF395	3,964	2,950	10 / 10	15,600		20,254
	TF450	4,504	2,950	10 / 10	15,300		20,415
	TF500	5,004	3,297	10 / 10	14,900		20,590
	TF550	5,504	3,464	10 / 10	14,500		20,773
3-Stage Full Free Lift	TF600	6,004	3,631	10 / 10	14,100		20,923
	TF650	6,504	3,798	10 / 10	13,700		21,207
	TF700	7,004	3,965	10 / 10	13,400		21,350

Load Capacity

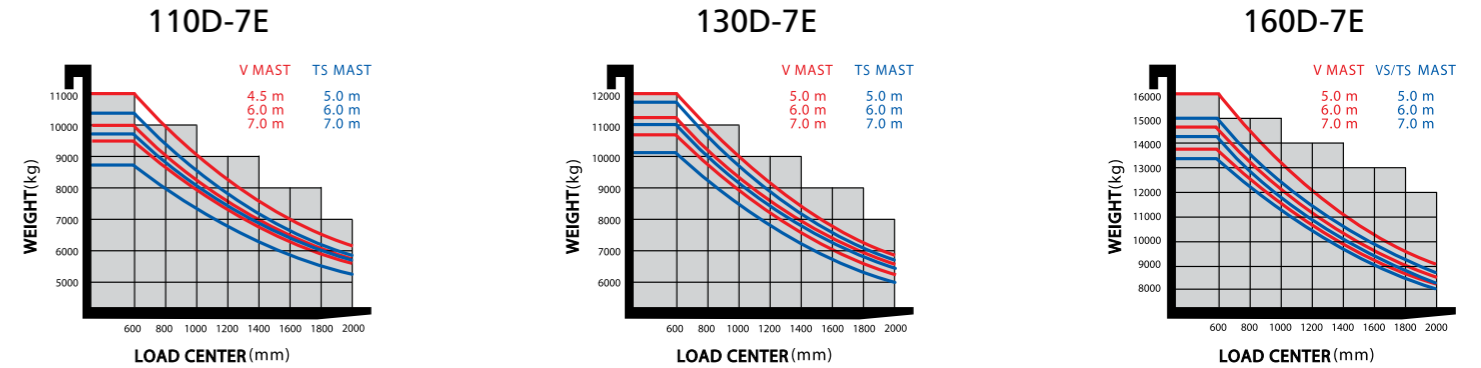

Optional Items

- FORK (L x W x T)(mm)
 - 110D-7E
75 x 200 x 1,200 / 75 x 200 x 1,500 / 75 x 200 x 1,800 / 75 x 200 x 2,100 / 85 x 200 x 2,440
 - 130D-7E
85 x 200 x 1,200 / 85 x 200 x 1,500 / 85 x 200 x 1,800 / 85 x 200 x 2,100 / 90 x 200 x 2,440
 - 160D-7E
90 x 200 x 1,200 / 90 x 200 x 1,500 / 95 x 200 x 1,800 / 95 x 200 x 2,100 / 95 x 200 x 2,440
- MAST : SIMPLEX MAST / TRIPLEX MAST
- MCV : 4 - SPOOL / 5 - SPOOL
- SEAT : NON HEAT / HEAT, Fabric / PVC Leather
- BEACON LAMP : AMBER / RED / BLUE
- FORK POSITIONER : 82 / 100
- INTEGRAL SIDE SHIFT + FORK POSITIONER
- HYDRAULIC LINE : 3 - SPOOL / 4 - SPOOL / 5 - SPOOL
- SOLID TIRE
- PNEUMATIC TIRE : 18PR LUG (14/16 ONLY)
- WIDE CARRIAGE (2,730 mm)
- SLIDING TYPE CARRIAGE (160 D-7E)
- HEAD GUARD
- REAR VIEW CAMERA & WEIGHT INDICATOR
- ESL (ENGINE START LIMIT)
- HANDS FREE
- SEPARATOR HOLDER TYPE CARRIAGE (160D-7E)

Dimension

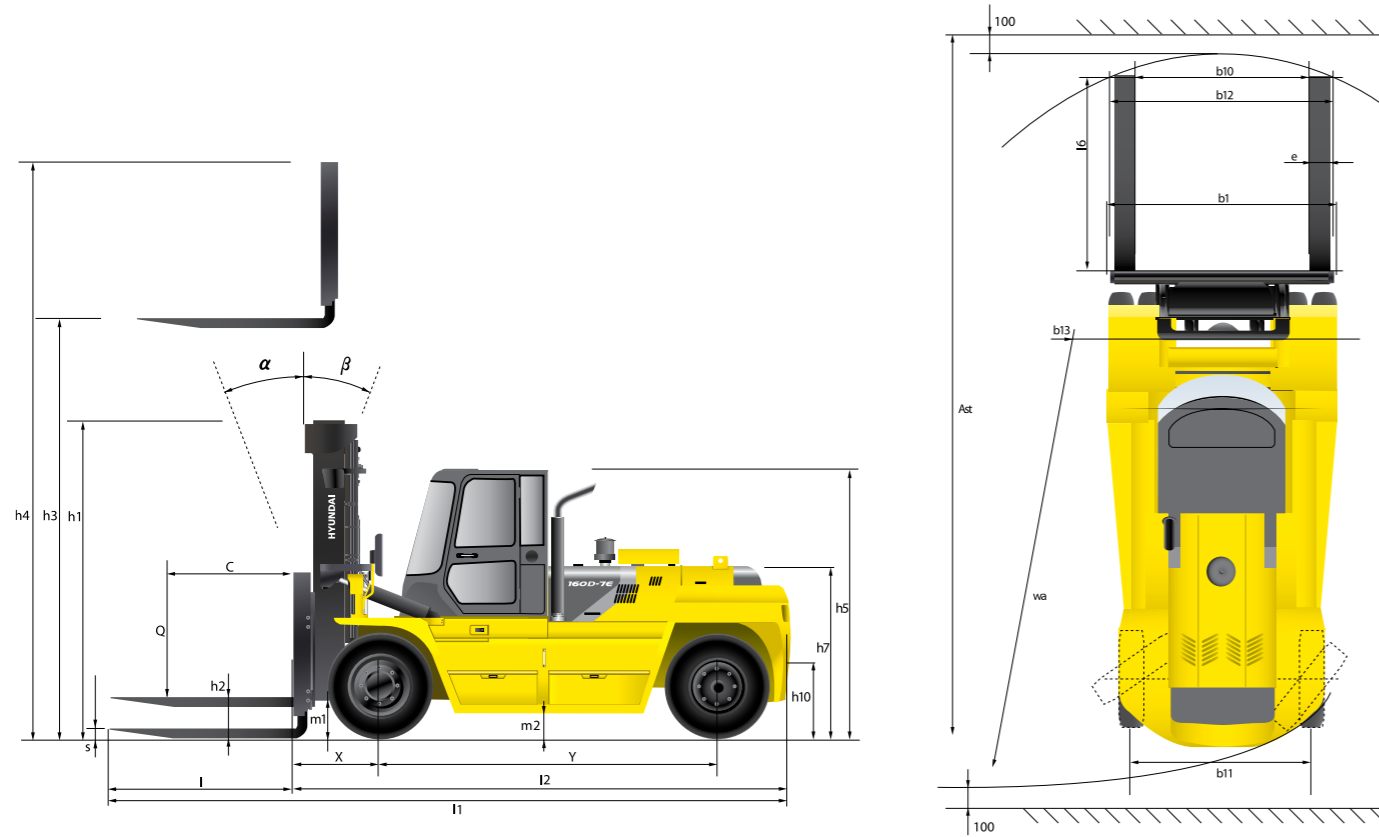

Various Attachments

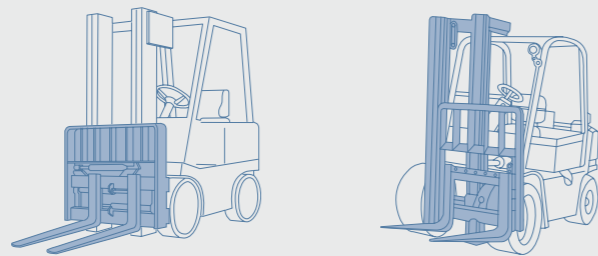

Specification

Identification				
1.1	Manufacturer		Hyundai	Hyundai
1.2	Manufacturer's type designation		110D-7E	130D-7E
1.3	Drive: electric (battery or mains),diesel,petrol,fuel gas,manual		DIESEL	DIESEL
1.4	Type of operation:hand,pedestrian,standing,seated,order-picker		seated	seated
1.5	Load capacity / rated load	Q (t)	11.0	16.0
1.6	Load center distance	c (mm)	600	600
1.8	Load distance, center of drive axle to fork	x (mm)	760	815
1.9	Wheelbase	y (mm)	2,900	3,300
Weights				
2.1	Service weight	kg	15,797	16,503
2.2	Axle loading, loaded front/rear	kg	23,717 / 3,080	26,702 / 2,802
2.3	Axle loading, unloaded front/rear	kg	7,577 / 8,220	7,605 / 8,898
Wheels, Chassis				
3.1	Tires:solid rubber, superplastic, pneumatic, polyurethane		Pneumatic	Pneumatic
3.2	Tires size, front(width x Φ)		16PR	20PR
3.3	Tires size, rear(width x Φ)		16PR	20PR
3.5	Wheels, number front x rear (x=driven wheels)		4 x 2	4 x 2
3.6	Track width, front	b10 (mm)	1,842	1,842
3.7	Track width, rear	b11 (mm)	1,910	1,955
Basic Dimensions				
4.1	Mast / fork carriage tilt forward / backward(α / β)	degrees	15 / 12	15 / 12
4.2	Lowered mast height	h1 (mm)	3,000	3,250
4.3	Free lift	h2 (mm)	0	0
4.4	Lift height	h3 (mm)	3,005	3,010
4.5	Extended mast height	h4 (mm)	4,465	4,710
4.7	Overhead load guard (cab) height	h5 (mm)	2,900	2,935
4.8	Seat height / standing height	h7 (mm)	1,723	1,749
4.12	Coupling height	h10 (mm)	600	600
4.19	Overall length	l1 (mm)	5,690	6,255
4.20	Length to face of forks	l2 (mm)	4,340	4,905
4.21	Overall width	b1 (mm)	2,450	2,497
4.22	Fork dimensions	s / e / l (mm)	75x200x1,350	85x200x1,350
4.23	Fork carriage ISO 2328, class / type A,B		Pin Mount	Pin Mount
4.24	Fork-carriage width	b12 (mm)	2,362	2,488
4.31	Ground clearance, loaded, under mast	m1 (mm)	270	270
4.32	Ground clearance, centre of wheelbase	m2 (mm)	330	330
4.33	Aisle width for pallets 1000x1200 crossways	Ast (mm)	6,496	7,131
4.34	Aisle width for pallets 800x1200 lengthways	Ast (mm)	6,496	7,131
4.35	Turning radius	Wa (mm)	4,191	4,746
4.36	Smallest pivot point distance	b13 (mm)	1,516	1,748
Performance Data				
5.1	Travel speed, Unloaded	km/h	33.3	32.3
5.2	Lift speed, Loaded/Unloaded	m/s	0.44 / 0.51	0.35 / 0.45
5.3	Lowering speed, Loaded/Unloaded	m/s	0.51 / 0.46	0.43 / 0.39
5.5	Drawbar pull, Loaded	N	122,255	116,982
5.7	Gradient performance, Loaded	%	47	32.4
5.9	Acceleration time, Loaded/ Unloaded(10m)	sec	-	-
5.10	Service brake		hydraulic	hydraulic
Engine				
6.1	Engine manufacturer / type		HYUNDAI HE6.7	HYUNDAI HE6.7
6.2	Engine power acc. to ISO 1585	kW	142	142
6.3	Rated speed	1/min	2,200	2,200
6.4	No. of cylinder / cubic capacity	/cm³	6 / 6,700	6 / 6,700
6.5	Fuel consumption acc. To VDI cycle	ℓ/h	11.0	11.5
Other Details				
8.1	Type of drive control		ToqueConvert 3 / 3	ToqueConvert 3 / 3
8.2	Operating pressure for attachments	bar	150	150
8.3	Oil volume for attachments	l/min	295	295
8.4	Sound level at driver's ear according to DIN 12053	db(A)	82	82
8.5	Tow coupling, type DIN		-	-